

DO NOT SCALE OFF DRAWING. ALL DIMENSIONS IN MM

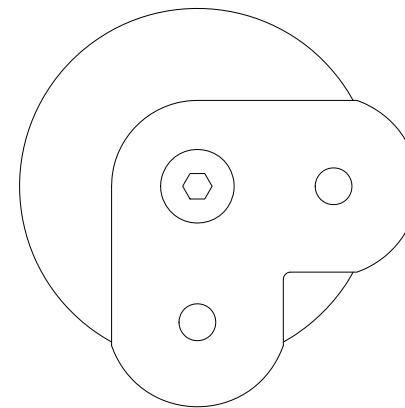
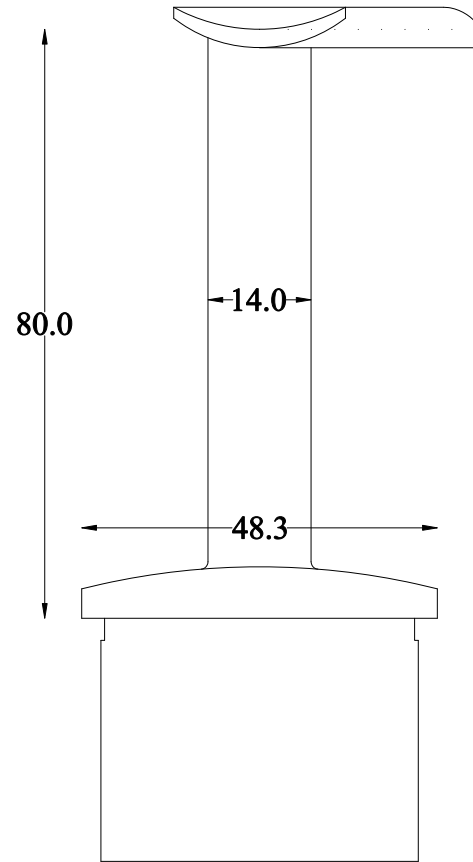

Drawn By	J. Pytlinski	Part Number	48FIG.233.90
Approved By	D. Worley	Description	Stand Off Rail Support C/W 90° Saddle
Revision No.		Material Spec	Stainless Steel AISI 304 or AISI 316
Date	21/01/2010	Copyright	This drawing is the property of Seagull Fittings Ltd copyright is reserved by them

Drawing Number:

N/A

Seagull Balustrades
90 Roebuck Lane
West Bromwich
West Midlands
B70 6QX